

FLY Series-Multifunction Panel Meter



INDEX

1. Introduction :
2. Features :
3. Model Selection :
4. Specification
5. Integer Flow :
6. Auxiliary Supply :
7. PT Supply :
8. CT Connection :
9. Wiring Diagrams :
10. Key Functions :
11. Meter Measurement Scrolling :
12. KVA Measurement Method :
13. Trip function :
14. Setting/Configuration Modes :
- 15 . Programming mode Details :
16. Dimensional details_



True
RMS

1. Introduction :

FLY series meters are compact digital power meter, equipped with 10 digit, 2 row LCD display. Top row Displays Measurements & bottom row displays the parameters. Three navigator keys & LCD display simplifies meter configuration.

FLY series are available with accuracy class of 1.0 IEC6205321/ (Optional 0.5,0.2 IEC- 62053-22), Modbus Communication On RS 485 Is Optional.

2. Features :

- Trip Function enables user to have record of integration Value. from a selected time
- Auto scaling of Kilo Giga, Mega and decimal Point
- Password protection for user programmable parameters
- Modbus Communication on RS - 485 (Optional)
- Meter / Wiring configuration is field programmable as Star/ Delta/ Single Phase connection.
- Accuracy Class 1.0 IEC 62053 - 21/ (Optional 0.5;0.2 IEC 62053-22)
- Selectable auto & manual scroll of display
- Poly carbonate Cabinet
- IP 65 from front

3. Model Selection :

MEASUREMENT	PARAMETERS	FLY-1100	FLY-1103	FLY-1300	FLY-1400	FLY-1403	FLY-1900
Basic							
Voltage	VLL, VLN	■	■		■	■	
Line Current	IR, IY, IB	■	■		■	■	
Frequency	Hz	■	■		■	■	
Average	I						
Neutral Current	Calculated						
Unbalance	%1 %V						
Phase Angle	PA						
Power							
Apparent Power	Va, Va1, Va2, Va3		■		■	■	
Active Power	W, W1, W2, W3		■		■	■	
Power Factor	Pf, Pf1, Pf2, Pf3						■
Reactive Power	Var, Var1, Var2, Var3						
Integration Present							
Active Energy	Wh						■
Reactive Energy	±Varh						
Power Energy	Vah						
Run Hour	RnHr						
Load Hour	Ldhr						
Interrupts	Nos.						
Old							
Active Energy	Wh						■
Reactive Energy	±Varh						
Power Energy	Vah						
Run Hour	RnHr						
Load Hour	Ldhr						
Interrupts	Nos.						
Trip							
Active Energy	Wh						
Reactive Energy	±Varh						
Power Energy	Vah						
Run Hour	RnHr						
Load Hour	Ldhr						
Interrupts	Nos.						
THD							
THD	V&I		■			■	

MEASUREMENT	PARAMETERS	FLY-2010	FLY-2412	FLY-2811	FLY-2812	FLY-2415	FLY-2552
Basic							
Voltage	VLL, VLN		■			■	■
Line Current	IR, IY, IB		■			■	■
Frequency	Hz		■			■	■
Average	I						■
Neutral Current	Calculated						■
Unbalance	%1 %V						■
Phase Angle	PA						■
Power							
Apparent Power	Va, Va1, Va2, Va3		■	■	■	■	■
Active Power	W, W1, W2, W3		■	■	■	■	■
Power Factor	Pf, Pf1, Pf2, Pf3						■
Reactive Power	Var, Var1, Var2, Var3						■
Integration Present							
Active Energy	Wh	■	■	■	■	■	■
Reactive Energy	±Varh			■	■	■	■
Power Energy	Vah			■	■	■	■
Run Hour	RnHr		■	■	■	■	■
Load Hour	Ldhr		■				■
Interrupts	Nos.		■				■
Old							
Active Energy	Wh	■	■	■	■	■	■
Reactive Energy	±Varh			■	■	■	■
Power Energy	Vah			■	■	■	■
Run Hour	RnHr		■	■	■	■	■
Load Hour	Ldhr		■				■
Interrupts	Nos.		■				■
Trip							
Active Energy	Wh		■		■	■	■
Reactive Energy	±Varh				■	■	■
Power Energy	Vah				■	■	■
Run Hour	RnHr		■		■	■	■
Load Hour	Ldhr		■				■
Interrupts	Nos.		■				■
THD							
THD	V&I					■	

4. Specification

Accuracy	: Class 1.0 / Class 0.5
Input Voltage	: Vr, Vy, Vb, Vn
Input Voltage Range	: 18-520V (L-L) / 10V-300V (L-N)
Isolation Voltage	: 2000V
Input Current	: Ir, Iy, Ib
Input Current	: 50mA-6A (Accuracy range)
Starting Current	: 1-200mA (programmable)
CT Burden	: 0.2VA max. per phase
Current with stand	: 10A continuous, 50A for 1 Second
Input Frequency	: 40 to 70Hz
Auxiliary Supply	: 35-300V AC/DC
Auxiliary supply burden	: <4VA
Display	: 2 Row10 Digit (LCD)
Display Scrolling	: Automatic/Manual
Pulse Output Contact Rating	: 50mA (Optional, Max. Pulse width 250+-50ms 24VDC)
Communication	: Modbus Comm. on RS-485 (Optional)
CT Primary setting	: 1A to 999kA
CT Secondary setting	: 1A to 10A
PT Primary setting	: 50V to 999kV
PT Secondary setting	: 50V to 999 V

5. Integer Flow :

V.PRI x A.PRI x 1.732	Max Reading (Wh/VAh)	Max time to reset the integrator in Run Hours	Max time to overflow in months at full scale
1VA to 40KVA	9999999.999 KW	100 years	28 years
40KVA to 40MVA	9999999.999 MW	100 years	28 years
>40MVA	9999999.999 GW	100 years	Depends upon setting

6. Auxiliary Supply :

SMPS Supply with input range 35-300V AC/DC. Burden on auxiliary supply is less than 4VA.

7. PT Supply :

FLY can withstand maximum voltage of upto 1000V. Meter can be configured for 3P-4Wire, 3P-3Wire/1Phase connection. Maximum Burden on PT is Less than 0.1VA

8. CT Connection :

Nominal Current of FLY Meter is 6 Amp. Maximum Continuous Current is 10Amp & Current with stand is 50A for 1 Second. Burden on CT less than 0.2VA

9. Wiring Diagrams :

9.1 3-phase 4-wire star/wye connection

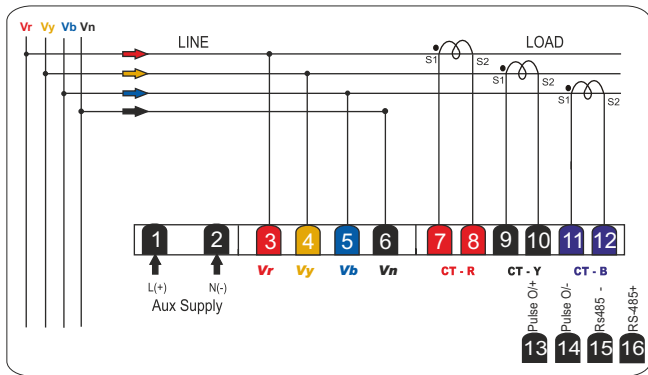

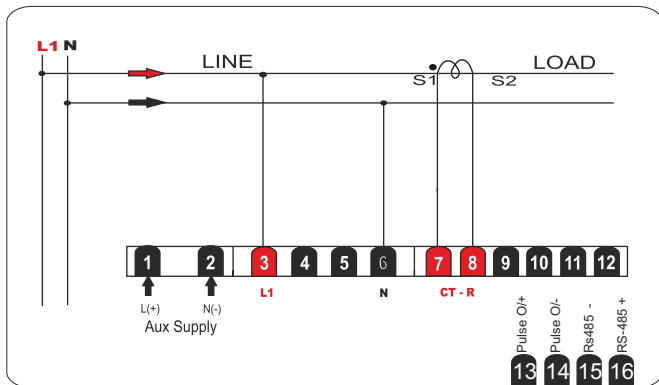

9.2 Single phase connection

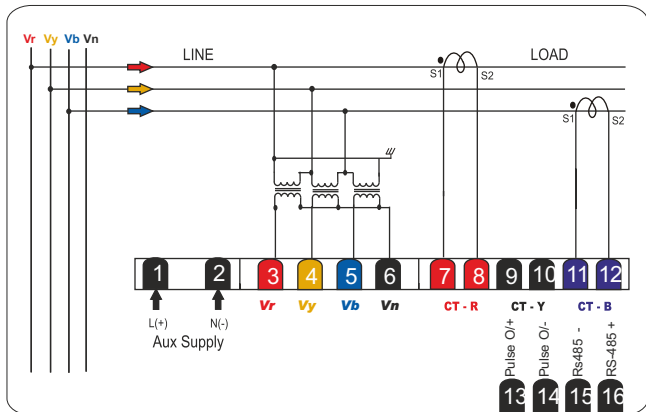

9.3 3-phase 3-wire delta connection



10. Key Functions :

KEY	In EDIT Mode	In Measurement Mode
 Increment	Increment the value of selected parameters.	Long push (for 3sec approx for Scroll ON/OFF
 Decrement	Decrement the value of selected parameters.	Scrolling between different measurements parameters.
 Next	Scrolling to the next parameter in EDIT mode	Scrolling between different measurements parameters.

11. Meter Measurement Scrolling :

Display can be set as auto scroll/Manual scroll Scrolling mode can be changes from auto to manual & Vice versa by long press (for 3 sec) of increment key.

In auto scroll the measurement display changes to next page automatically while in manual mode (scroll) measurement page can be selected by pressing DEC & NEXT

12. KVA Measurement Method :

3d Recommended method of measurement in case of distorted/ unbalance load condition.

Arithmetic Conventional method of measurement.

13. Trip function :

Trip function enables the used to have reading of selected cumulative measurement between any two selected time. Please refer 14.5 for resetting the trip reading.

14. Setting/Configuration Modes :

Following configuration modes are available in Fly series of meters :

14.1 EDIT Mode :

This mode is password protected. Set values can be changed in this mode (Editable setting are indicated in table..... along-with setting range)

14.2 View Mode :

It is possible to view all the set values even without entering the password. Change of values is not permitted in this mode.

14.3 Old Mode :

User can view old data/value of all available integration parameters (eg. Wh, Oh, Lh, interrupts)

14.4 Trip Mode :

This enables user to view log of integration parameter since the last reset. User can reset trip data at any moment. Resetting of trip values, restart integration process, which keeps on going till it is resettled again.

14.5 RST Trip

Reset of trip data is password protected. Entering correct password in this mode, resets trip values of integration parameter.

14.6 RST Pass :

New password can be programmed in this mode once the password is changed. It is not possible to retrieve the old password hence it is recommended to have a record new password once it is changed.

15 . Programming mode Details :

15.1 EDIT Mode :

Parameter values can be changed in 'EDIT' mode, 'EDIT' mode is password protected.



Press **decrement** and **next** key together



EDIT appears on display.



Press **next** key.
Display will show **PASS 000**



Press **increment** key to reach **123** which is the default password.
Once **123** is set



Press **next** key,
Display will show **PASS OK**.



Press **next** key.
First editable parameter which in PT primary value appears on display.

Use **increment**, **decrement** to change parameter values, **next** to move forward to next parameter. All editable parameters with setting limits & sequence are mention in table given below :

Example-To change the voltage primary from**415** to **1.2 kV** follow the following steps :-

- a) Press **decrement** and **next** key together
- b) **EDIT** appears on display.
- c) Press **Next** key.
- d) Display will show **PASS 000** , press **increment** key to reach **123** which is the default password.
- e) Once **123** is set, press **next** key, display will show **PASS OK**.
- f) Press **next** key.
- g) Display will show **PTP V 415**, use **decrement** key to reach **120** and press **next** key
- h) Display will show **PTP d 120**, use **increment/decrement** key to put decimal at **1.20**. Press **next** key.
- i) Display will show **PTP U 1.20**, use **increment/decrement** key to change unit to **KILO**, display will show **PTP U 1.20** with a **K** subscript meaning the value is **1.2 kV**.

DISPLAY	DESCRIPTION	RANGE
PTP V	PT Primary Voltage	50-999
PTP d	PT Primary Decimal Place	-
PTP U	PT Primary Voltage Unit	Decimal, Kilo
PTS	PT Secondary Value	50-999
CTP V	CT Primary Value	1-999
CTP d	CT Primary Decimal place	-
CTP U	CT Primary Unit	Decimal Kilo
CTS	CT Secondary Current	1-10
KVA	KVA Measurement Mode	3d/ARTH
SYS	System Configuration	3P4W/3P3W/1P
STAI	Starting Current	1mA-200mA
DEV ID	Device Identification for Communication	1-247
Baud Rate	Communication baud rate	1200, 2400, 4800, 9600,19200
Comm PARI	Communication parity bit	Even, odd None
Stop Bit	Stop Bit for Communication	1-2

15.2) View Mode:

User can view all set values in this mode without entering password :



Press **decrement** and **next** key together



EDIT appears on display



Press **increment** key.
Display will show **View**



Press **forward** key to enter into **view** mode.
First editable parameter which in PT primary Value appears on display

15.3 OLD Setting Mode :



Press **decrement** and **next** key together



EDIT appears on display
Press **increment** key.



Display will show **View**



Press **increment** key and the
Display will show **OLD**.



Press **next** key to enter the **OLD** mode.
Display will show old KWh Value
Press next key



Display will show old on hour value



Press next key
Display will show old load hour value



Press next key
Display will show old interrupt value

15.4 TRIP Setting Mode :

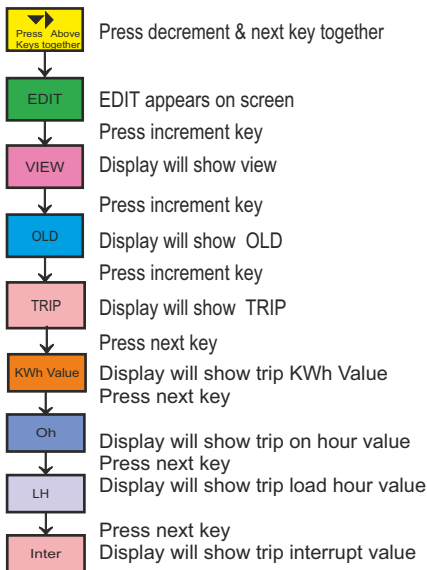

15.5 RST Trip Setting ;

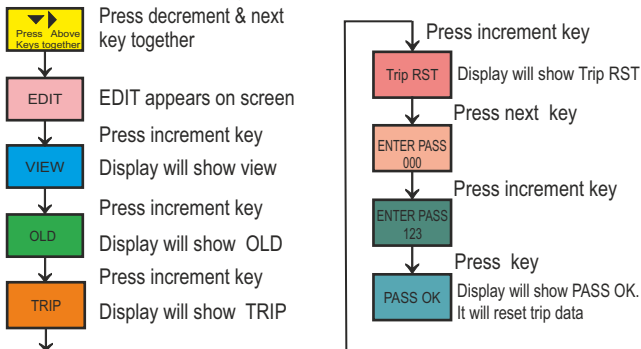

15.6 RST Password :

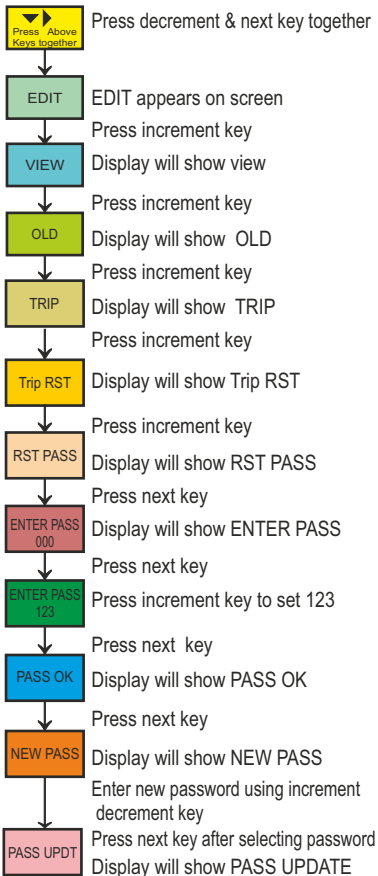

15.7 Communication Setting Optional :

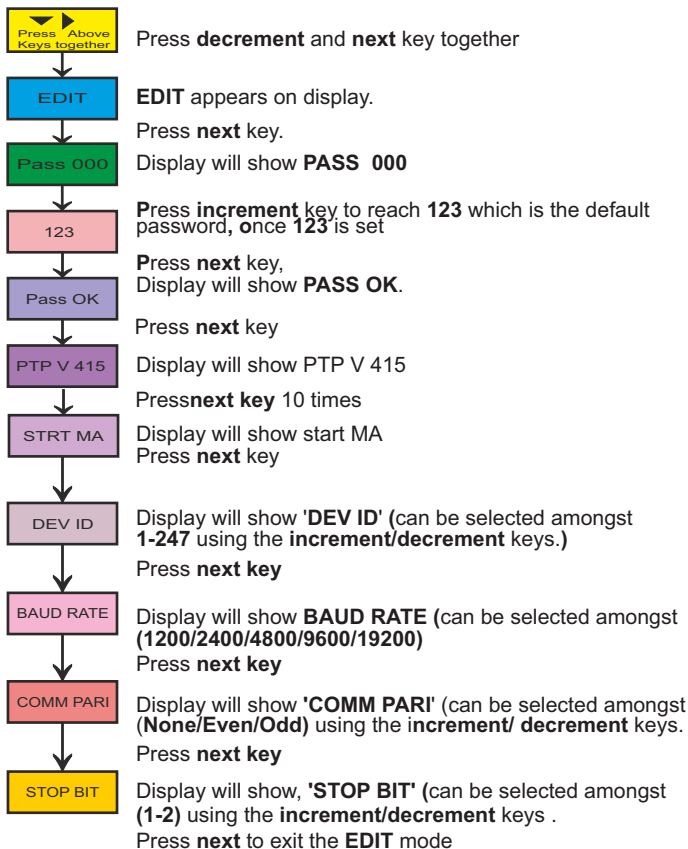

16. Dimensional details_

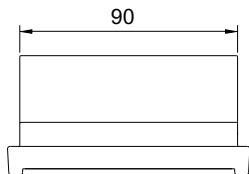

Top View

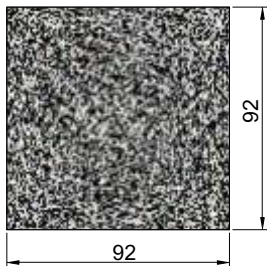

Panel Cutout

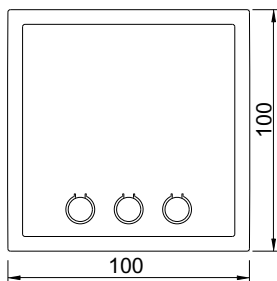

Front View

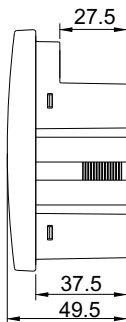

Side View

All dimensions are in mm.

MRM *PROCOM*[®] Pvt. Ltd.
Plot No. 20-21, Industrial Estate
Sector-59 (II), HUDA, Faridabad-121004, Haryana
Phone: 0129-4700400 (10 Lines), E-mail : info@mrmprocom.com
Website : www.mrmprocom.com