

OPERATING INSTRUCTIONS ECON-F



INDEX

- 1. Introduction**
- 2. Protection, Supervision Salient features**
- 3. Digital Output**
- 4. Digital Input**
- 5. Indication**
- 6. Front Panel Switch**
- 7. Setting Procedure**
- 8. Technical Specification**
- 9. Model Selection**
- 10. Wiring Diagram**
- 11. Analog Channel Data**
- 12. Dimensional Drawing**

1.0 Introduction

- ECON- F is an Engine Control / Protection Unit for engines used for NON DG applications.
- The controller can measure signals from either MPU or charging alternator to calculate RPM.
- ECON provide choice of Variety of sensor selection from predefined selection chart.
- In critical operation it is possible to disable or debar tripping of engine via an external digital input.
- 128x64 pixel graphical display enhance convenience in configuration of controller.

2.0 Protection, Supervision Salient Features

Protection

- Low Lube Oil Pressure(LLOP)
- High Water Temp. (HWT)
- Oil Temp.
- Emergency off
- Fuel level
- Charging Alternator Fail/V-Belt failure

Display and Measurement

- Battery Voltage
- Engine Run Hour
- RPM
- Water Temp in degree centigrade
- Fuel level in %
- Oil Temp in degree centigrade
- Service Hour

3.0 Digital Output

Eight digital output (seven negative and one positive) are available, four output contacts programmable.

- Start/Crank (Battery Negative)
- Charging Alternator (Battery positive)
- Solenoid (Battery Negative)
- Annunciation 1 (Battery Negative)
- Annunciation 2 (Battery Negative)
- Annunciation 3 (Battery Negative)
- Annunciation 4 (Battery Negative)
- Hooter (Battery Negative)

4.0 Digital Input

ECON can measure / detect three Analog, seven digital and one pulse input. These inputs are as mentioned below.

1. **LLOP Sensor** : Resistive sensor can be connected to LUBE Oil PRESSURE terminal(2). Pre Programmed sensor value (Listed in TABLE 5.1) can be assigned to LLOP input.
2. **HWT Sensor** : Resistive sensor can be connected to Water Temperature terminal(3). Pre Programmed sensor value (Listed in TABLE 5.1) can be assigned to HWT input.
3. **Fuel / Oil Temp. sensor** : Resistive sensor can be connected to Fuel / Oil Temp. sensor terminal (4).
4. **LLOP Switch** : Oil pressure switch can be connected to LLOP switch terminal (8) . The input is activated on connection of DC negative at terminal no. 8. on activation stop command is issued to the engine and the fault is indicated on front LED.
4. **Oil Temp. Switch** : Oil Temp. switch can be connected to oil temp. switch terminal (10) . The input is activated on connection of DC negative at terminal no. 10. on activation stop command is issued to the engine and the fault is indicated on front LED.
5. **HWT Switch** : Water Temperature switch can be connected to HWT switch terminal (9) . The input is activated on connection of DC negative at terminal no. 9. on activation stop command is issued to the engine and the fault is indicated on front LED.
6. **Emergency Off** :
The input is activated on connection of DC negative at terminal no. 11. on activation stop command is issued to the engine and the fault is indicated on front LED.
7. **Protection Debar** : The input is activated on connection of DC negative at terminal no. 12. on activation ECON disable trip function on all the faults.
8. **Remote Start** : ECON issues start command to engine on receipt of DC negative at remote start terminal.
9. **Remote Stop** : ECON issues stop command to engine on receipt of DC negative at remote stop terminal.

5.0 Indication





Listed below are the two LED indication available on front of ECON-F

Warning : Blinks on any case of warning.

Fault : Blinks on any fault which results in engine shutdown.

6.0 Front Panel Switch

ECON – F has four switch provided on its front panel. Switch can h more than one functions assigned to them. The table below describes the operation of these

Switch Symbol	Switch Function	Description
	Increment /Start	Programming Mode: It is used to increment the value of the parameters under programming. & it is used to issue the crank/ start command to DG
	Decrement /Stop	Programming mode: It is used to decrement the value of the parameter under programming &. It is used to issue the stop command to DG
	Next	Normal operation mode: In this mode, it is used to change the parameters being displayed on LCD. Programming Mode: Next key is used to select the next parameter to be programmed.
	Reset	Either to reset the fault / Or press enter and reset together to select programming mode.

7.0 Setting Procedure / Menu

ECON is user/site configurable. User can view all parameters, fault history, events no. of start/stop and can also edit, system parameter (password protected), engine / generator parameter, annunciation setting,RS485 parameter clock and password. Following is the sequential procedure to edit. view all the menu and submenus

Press “R” & “Enter“ switch simultaneously.

The LCD shall display, “System Parameter”

1. System Parameter

- System parameter are password protected.
- To enter “system parameter” press “Enter”.
- ECON will request for password, LCD will display “ Enter Password”
- System parameter can be edited by entering correct password or else can be viewed by entering “0” as password.

2. Engine / Generator Parameter

- To go to next menu after system parameter, press “Increment”.
- The LCD shall display “Generator Parameter”.
- Generator parameter can modified / viewed by pressing “Enter”.

3. Annunciation Setting

- To go to next menu after generator parameter, press “Increment”.
- The LCD shall display “annunciation setting”.
- Annunciation settings can modified / viewed by pressing “Enter”.

4. Comm RS-485 Parameter

- To go to next menu after Annunciation parameter, press “Increment”.
- The LCD shall display “Comm RS-485” parameter setting.
- Comm RS-485 parameter settings can modified / viewed by pressing “Enter” key.

5. Display History

- To go to next menu after “Comm RS-485” parameter, press “Increment”.
- The LCD shall display “Display History”.
- Trip record / history can be viewed by pressing “Enter”.
- ECON keep a record of last 32 tripping with date and time stamp.
- Tripping records are updated on first in first out basis

6. Display Event

- To go to next menu after history press “Increment”.
- The LCD shall display “Display Event”.
- Display Event can be viewed by pressing “Enter”.
- ECON keep a record of last 32 event with date and time stamp.
- Event record is updated on first in first out basis.

7. Display Start Stop

- To go to next menu after event press “Increment”.
- The LCD shall display “Display Start / Stop”.
- Start Stop can viewed by pressing “Enter”.
- ECON keep a record of last 64 start and stop event with date and time stamp.
- Start/ stop record is updated on first in first out basis.

8. Reset Service Alarm

- To go to next menu after Start-Stop press “Increment”.
- The LCD shall display “Reset Service Alarm”.
- Service due hour can be reset by pressing start button after entering in to this menu.





9. Adjust Clock



- To go to next menu after “Service Alarm” press “Increment”.
- The LCD shall display “Adjust Clock”.
- Time can be modified / viewed by pressing “Enter”.

9. Reset Password

- To go to next menu after “Adjust Clock” press “Increment”.
- The LCD shall display “Reset Password”.
- Password can be modified by pressing “Enter”
- ECON will request for the present password, after feeding correct password change password will be requested and the password will be replaced by new password on pressing start button..







Parameter Mode			
Parameter	Options/Limits	Description	Default Setting
<p>A. System Parameter</p> <p>System parameters are the parameters which are programmed once during initial installation and does not require frequent changes. As these are critical parameter and hence are password protected. It is possible to view system parameter without knowing the password but editing is possible only after entering correct password</p> <p>All system parameters are listed below along with their default value and minimum / maximum variation range. Values can be increased or decreased by pressing up/start and down/stop button respectively . Next parameter can be selected by pressing next button</p>			
Solenoid Type 	1: Pull to Start 2: Pull to Stop	<p>Pull To Start</p> <p>In this mode fuel solenoid contact changes from Open to Close at the time of cranking and remains close till the genset is running. For stopping the generator this contact opens.</p> <p>Pull To Stop</p> <p>In this mode fuel solenoid contact remains open at the time of cranking and till the genset is running. For stopping the generator this contact closes for a user programmed time.</p>	Pull to Stop







<p>LLOP Sensor</p> 	<p>1: Type A 2: Type B 3: M&M 4: MNEPL 5: VE 6: TMTL 7: HUAFANG 8: TATA 9: GC(VDO) 10: GC(Murphy) 11: MVD 12: LUBI 13: 4-20 mA10bar 14: 4-20 mA16bar 15: Disabled</p>	<p>Select the installed sensors. If no sensor is installed select "Disabled"</p>	<p>GC(VDO)</p>
<p>Fuel Sensor</p> 	<p>1: Type A 2: Sam 0 3: Sam 1 4: Disabled</p>	<p>Select the installed sensors. If no sensor is installed select "Disabled"</p>	<p>Type A</p>
<p>Oil Temp. Sensor</p> 	<p>1: Type A 2: Type B 3: M&M 4: MNEPL 5: VE 6: TMTL AIR 7: TMTL WATER 8: HUAFANG 9: TATA 10: GC(VDO) 11:GC(Murphy) 12: Disabled</p>	<p>Select the installed sensors. If no sensor is installed select "Disabled"</p>	<p>TMTL Water</p>
<p>HWT Sensor</p> 	<p>1: Type A 2: Type B 3: M&M 4: MNEPL 5: VE 6: TMTL AIR 7: TMTL WATER 8: HUAFANG 9: TATA 10: GC(VDO) 11: GC(Murphy) 12: LUBI 13: Disabled</p>	<p>Select the installed sensors. If no sensor is installed select "Disabled"</p>	<p>TMTL Water</p>





Sensor Open 	1: Warning 2: Fault 3: Disabled	The action to be taken if the sensor is found to be open.	Warning
Pulses/Revolution 	1-300	No of pulses, from Magnetic Pickup unit or W point of charging alternator, in one revolution of the engine. This shall be used to calculate the RPM.	134
Start Stop Config 	1: Separate keys 2: Only Start key	This parameter decides as to how the remote start and stop shall be done. Option 1: Separate keys is selected than a single pulse on remote start shall the engine and another pulse on remote stop shall stop the engine. The duration of these pulses shall be more than 200msec. Option 2: In this option the engine shall be started and kept working till Remote start is pulled low. As soon as the pin is released the engine shall stop. To attempt a new start cycle, after the engine fails to start, the remote start pin must be released for some time and again pulled low. * Option 2 should not be selected if the start and stop functions are to be executed from front keys.	Separate keys







B. Engine/Generator Parameter





All the Engine programmable parameters are listed below along with their default value and minimum / maximum variation range. Values can be increased or decreased by pressing up/start and down/stop button respectively . Next parameter can be selected by pressing next button.

Maximum RPM 	600-4000	Maximum allowed RPM of Engine. Engine running at speed above this is treated as over speeding and a fault is registered and engine stopped.	1600
Minimum RPM 	600-4000	Minimum allowed RPM of Engine. running at speed below this is treated as over speeding and a fault is registered and engine Stopped.	600
RPM Delay 	1-999 Sec	Duration for which engine is allowed to operated outside the set RPM limits. If it continues to operate beyond the limits for more than the set time a fault condition is registered and engine stopped.	3
Action Over RPM 	<ol style="list-style-type: none"> 1. No action 2. Warning 3. Engine Shutdown 	The action to be taken if the Over RPM fault occur <ol style="list-style-type: none"> 1. The fault is neglect. 2. This generate warning, fault with annunciation and log to history. 3. This stop the engine, fault with annunciation and log to history. 	Warning
Action Under RPM 	<ol style="list-style-type: none"> 1. No action 2. Warning 3. Engine Shutdown 	The action to be taken if the Under RPM fault occur <ol style="list-style-type: none"> 1. The fault is neglect. 2. This generate warning, fault with annunciation and log to history. 3. This stop the engine, fault with annunciation and log to history. 	Warning
Pick Up RPM 	80-1000	The engine stalling RPM. This parameter defines the RPM above which the engine will not stall and hence can be treated as running. This is used to detect the engine running condition after crank.	300

Service Due Hour 	10-999Hrs	Service due warning is generated after the engine has logged these many hours.	500
pump pre 	Disable 1-999	Start with cranking and remains there until it gets the stopping command	2
Fuel warn Level 	Disable 11-80	Monitoring value for the fuel level below which fuel level warning is generated	24%
Fuel warn delay 	1-999 Sec	Monitoring time for the fuel level below which fuel level warning is generated.	10
Fuel Trip Level 	5-80	Monitoring time for the fuel level below which fuel trip warning is generated.	15
Fuel Trip delay 	1-999 Sec	Monitoring time for the fuel level below which fuel trip warning is generated.	10
Action Fuel Fault 	1. No action 2. Warning 3. Disabled	The action to be taken if the fuel fault occur 1. The fault is neglect. 2. This generate warning, fault with annunciation and log to history. 3. Disabled	disable

Oil temp Trip Level 	40-250oC	The maximum OIL temperature up to which the engine is allowed to operate.	115°C
Oil temp trip delay 	1-999Sec	Monitoring time for the Oil temp level to avoid false tripping of the engine.	3
Action Oil temp Fault 	1. No action 2. Warning 3. Engine Shutdown	The action to be taken if the Oil temp fault occur 1. The fault is neglect. 2. This generate warning, fault with annunciation and log to history. 3. This stop the engine, fault with annunciation and log to history.	Warning
LLOP Trip Level 	0.4-8.5Kg/cm ²	The minimum lubricant oil pressure on which the engine is allowed to operate. A drop of pressure below the set limit shall trigger a fault condition thereby stopping the engine	1.5Kg/cm ²

LLOP Trip Delay 	1-999 Sec	Duration for which the low lubricant oil pressure can be tolerated.	3
Action LLOP Fault 	1. No action 2. Warning 3. Engine Shutdown	The action to be taken if the LLOP fault occur 1. The fault is neglect. 2. This generate warning, fault with annunciation and log to history. 3. This stop the engine, fault with annunciation and log to history.	Warning
HWT trip level 	40-250°C	The maximum coolant temperature up to which the engine is allowed to operate.	96°C
HWT Trip delay 	1-999 Sec	The duration for which the engine is allowed to operate at temperature higher than the above set maximum temperature	3
Action HWT Fault 	1. No action 2. Warning 3. Engine Shutdown	The action to be taken if the HWT fault occur 1. The fault is neglect. 2. This generate warning, fault with annunciation and log to history. 3. This stop the engine, fault with annunciation and log to history.	Warning
ChgAlt-Vbelt 	1-999Sec	While the engine is running and the Charging alternator pin is not pulled low for this duration it is assumed that either the charging alternator or V-Belt has failed thereby generating a fault ondition and stopping the engine.	10





<p>Action ChgAlt-Vbelt Fault</p> 	<p>1. No action 2. Warning 3. Engine Shutdown</p>	<p>The action to be taken if the ChgAlt-Vbelt fault occur</p> <p>1. The fault is neglect. 2. This generate warning, fault with annunciation and log to history. 3. This stop the engine, fault with annunciation and log to history.</p>	<p>Warning</p>
<p>Crank On Time</p> 	<p>1-10 Sec</p>	<p>The maximum duration for which the engine can be cranked continuously. In case engine fails to start another attempt to start shall be attempted after some time.</p>	<p>3</p>
<p>Solenoid On Time</p> 	<p>1-60 Sec</p>	<p>The duration for which the Pull solenoid can be continuously energized while trying to stop the engine.</p>	<p>20</p>
<p>Gen stop monitoring delay</p> 	<p>1-60 Sec</p>	<p>The duration during which the generator can not be restarted while it's under generator stop monitoring time.</p>	<p>15</p>
<p>Auto Scroll</p> 	<p>1: Enabled 2: Disabled</p>	<p>Can be used to stop/start the automatic scrolling of the display parameters.</p>	<p>Enabled</p>
<p>Hooter On Time</p>	<p>1-999 Sec</p>	<p>Duration for which the hooter shall be . This setting is only available if the hooter is assigned to an DO.</p>	<p>15</p>

C. Annunciation Setting

It is possible to freely assign digital outputs to different fault. There are four (ANN1 , ANN2, ANN3 and ANN4) field programmable output.

It is also possible to assign same digital output to more than one fault(e.g. ANN1 can be assigned to fuel fault and HWT fault both, in this case ANN1 will activate on both the faults.

Ann fuel fault	1: No Annunciation 2:On DO Ann1 3:On DO Ann2 4:On DO Ann3 5:On DO Ann4	If desired, the oil temp fault can be announced at one of the annunciation Digital Output.	No Annunciation
Ann Oil Temp Fault	1: No Annunciation 2:On DO Ann1 3:On DO Ann2 4:On DO Ann3 5:On DO Ann4	If desired, the oil temp fault can be announced at one of the annunciation Digital Output.	No Annunciation
Ann HWT Fault	1: No Annunciation 2:On DO Ann1 3:On DO Ann2 4:On DO Ann3 5:On DO Ann4	If desired, the High water temperature fault can be announced at one of the annunciation Digital Output.	No Annunciation
Ann LLOP Fault	1: No Annunciation 2:On DO Ann1 3:On DO Ann2 4:On DO Ann3 5:On DO Ann4	If desired, the LLOP fault can be announced at one of the annunciation Digital Output.	No Annunciation
Ann RPM Fault	1: No Annunciation 2:On DO Ann1 3:On DO Ann2 4:On DO Ann3 5:On DO Ann4	If desired, the Over/Under speed fault can be announced at one of the annunciation Digital Output.	No Annunciation
Announce Unit OK	1: No Annunciation 2:On DO Ann1 3:On DO Ann2 4:On DO Ann3 5:On DO Ann4	If desired, the healthiness of the controller can be announced at one of the annunciation Digital Output	No Annunciation

D			
Device Id 	Modbus device ID	1	1-247
Baud Rate 	RS 485 Communication Baudrate	9600	1200 2400 4800 9600 19200
Parity 	RS 485 Communication Parity Bits	None	Even Odd None
Stop Bit 	RS 485 Communication Stop Bits	1	1 2
E Reset Service Alarm			
		Press INC to Reset Press DEC to esc	
F Adjust Clock			
	00.00 DD/MM/YY YY	Automatic real time based DG Start & Stop (Manual Controller Configuration) RTC Time and Date can be easily entered	00.00
G Reset Password			
		Three digit password protection for system settings Password can be change easily.	

8.0 Technical Specification

Auxiliary Voltage

8-35V/DC

Humidity

95 %

9.0 Model selection

Model	Analog Channel	RS-485 Comm
ECON-F-311	3(OIL TEMP., HWT, LLOP)	X
ECON-F-312	3(OIL TEMP., HWT, LLOP)	✓
ECON-F-321	3(FUEL, HWT, LLOP)	X
ECON-F-322	3(FUEL, HWT, LLOP)	✓

10.0 Wiring Diagram

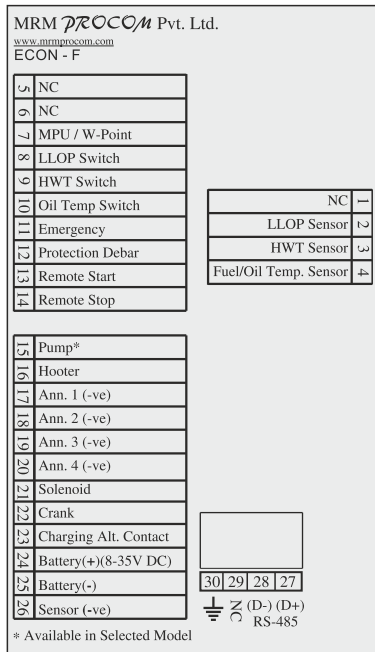

11.1 High Water Temperature Sensors Data :

Temp.	Resistance in ohms									
In °C	Type A	Type B	M&M	MNEPL	VE	Huafang	TATA	GC (VDO)	GC (Murphy)	TMTL Water
0	3282	1525	3282	3282	2363	2900	3192.6	3417	10613	3512
5	2765	1319	2765	2765	1873	2199	2461.1	2609	7764	2707
10	2247	1112	2247	2247	1383	1684	1914.6	2011	5743	2106
15	1730	906	1730	1730	1111	1301	1502.7	1564	4292	1653
20	1212	700	1212	1212	839	1015	1189.2	1227	3240	1308
25	1036	570	1036	1036	683	798	948.4	970	2469	1043
30	860	440	860	860	527	632	762.1	773	1898	838
35	684	365	684	684	434	505	616.7	621	1472	678
40	508	287	508	508	340	406	502.5	520	1050	552
45	426	260	426	426	283	327	412	438	885	453
50	343	232	343	343	226	247	340	356	720	374
55	291	205	291	291	190	214	282.1	288	560	310
60	238	178	238	238	154	187	235.5	220	410	259
65	203	151	203	203	131	154	197.6	183	360	217
70	167	123	167	167	107	120	166.6	145	300	183
75	144	96	144	144	92	101	141.2	128	240	155
80	120	69	120	120	76	85	120.2	110	193	132
85	104	62	104	104	66	74	102.8	95	160	113
90	88	54	88	88	55	62	88.3	80	145	97
95	77	46	77	77	48	55	76.2	71	120	83
100	66	38	66	66	41	47	66	61	100	72
105	58	35	58	58	36	41	57.4	52	90	63
110	50	31	50	50	30	36	43.8	45	80	55
115	45	27	45	45	27	31	38.5	40	70	48
120	39	23	39	39	23	27	33.9	34	55	42
125	34	19	34	34	21	24	30	30	45	37
130	30	15	30	30	18	21	26.6	27	38	33
135	27	11	27	27	16	18	23.7	23	33	29
140	25	0	25	25	14	15	21.1	21	29	26
145	23	0	23	23	12	12	18.9	18	25	23
150	21	0	21	21	10	10		16	22	20

Continues on Next Page

Temperature (°C)	LUBI (Resistance in ohms)
-55	47854
-50	34050
-45	24453
-40	17719
-35	12951
-30	9546
-25	7086
-20	5314
-15	4008
-10	3052
-5	2338
0	1807
5	1409
10	1107
15	876.6
20	699.2
25	560.2
30	453.5
35	368.2
40	300.8
45	247.4
50	204.7
55	169.9
60	141.8
65	119.2
70	100.6
75	85.26
80	72.54
85	62
90	53.19
95	45.81
100	39.6
105	34.39
110	29.96
115	26.18
120	22.94
125	20.17
130	17.78
135	15.74

11.2 High Water Temperature Sensors Data :

S.No	Temperature in °C	Resistance in ohms	
		TMTL AIR3C	TMTL AIR1C
1	80	300	300
2	85	279.3	273.1
3	90	258.5	246.2
4	95	237.8	223.8
5	100	217	208.5
6	105	201.3	193.1
7	110	185.5	177.7
8	115	169.8	162.3
9	120	154	146.9
10	125	138.3	131.5
11	130	122.5	116.2
12	135	106.8	100.8
13	140	91	85.4
14	145	76.3	70
15	150	61.5	57.3
16	155	46.8	44.7
17	160	32	32
18	165	30.3	30.3
19	170	28.5	28.7
20	175	26.8	27
21	180	25	23.6
22	185	22.3	20.2
23	190	19.5	16.8
24	195	16.8	13.4
25	200	14	10
26	205	13	
27	210	12	
28	215	11	
29	220	10	

11.3 Low Lube Oil Pressure Sensors Data

Pressure In Kg/cm ²	Resistance In Ohms										
	Type A	Type B	M&M	MNEPL	Volvo	TMTL	Hua- fang	TATA	GC (VDO)	GC (Murphy)	LUBI
0	10	10	10	10	15	10	10	10	10	240	10
0.5	16.5	20	16.5	20.5	19.5	21	20	20.5	20	214	18.75
1	23.5	30	23.5	31	24	32	30	31	30	189	27.5
1.5	30.2	40	30.2	41.5	28.5	43	40	41.5	41	166	36.25
2	37	50	37	52	33	54	50	52	52	147	45
2.5	49.5	58.7	49.5	70	40.5	62.7	58.7	61	61	129	53.75
3	62	67.5	62	88	48	71.5	67.5	70	70	115	62.5
3.5	74.5	76.2	74.5	106	54.5	80.2	76.2	79	79	102	71.25
4	87	85	87	124	61	89	85	88	88	91	80
4.5	96	93.5	96	142	63.5	97.7	93.5	97	97	81	88.75
5	105	102	105	160	66	106.5	102	106	106	71	97.5
5.5	114	110.5	114	178	72.5	115.2	110.5	115	115	61	106.25
6	123	119	123	196	79	124	119	124	124	51	115
6.5	133.5	127.2	133.5	214	82	132.7	127.2	132	132	41	123.75
7	143	135.5	143	232	85	141.5	135.5	140	139	31	132.5
7.5	152.5	143.7	152.5	250	87.5	150.2	143.7	148	146	24	141.25
8	162	152	162	268	90	159	152	156	152	20	150
8.5	171.5	159	171.5	286	95	167.7	159	164	159	16	158.75
9	-	-	-	-	-	-	-	-	-	-	167.5
9.5	-	-	-	-	-	-	-	-	-	-	176.25
10	-	-	-	-	-	-	-	-	-	-	184

11.4 Low Lube Oil Pressure Sensors Data (4-20mA Type)

S.No	Current (mA)	Pressure (Kg/cm ²)	Pressure (Kg/cm ²)
	4-20mA	(10 Bar)	(16 Bar)
1	4.0	0.0	0
2	5.6	1.0	1.6
3	7.2	2.0	3.2
4	8.8	3.0	4.8
5	10.4	4.0	6.4
6	12.0	5.0	8.0
7	13.6	6.0	9.6
8	15.2	7.0	11.2
9	16.8	8.0	12.8
10	18.4	9.0	14.4
11	20.0	10.0	16.0

11.4 Low Fuel Sensors Data :

S.No.	Fuel in %	Resistance in ohms		
		Type A	Sam_0	Sam_1
1	0	0	14	10
2	5	5	18	18.5
3	10	10	22	27
4	17	17	29.5	35.5.
5	20	34	37	44
6	25	51	55.5	52.5
7	30	68	74	61
8	35	85	92	69.5
9	40	102	110	78
10	45	110.5	124.5	86.5
11	50	119	139	95
12	55	127.5	149	103.5
13	60	136	159	112
14	65	144.5	165	120.5
15	70	153	171	129
16	75	157.7	172.5	137.5
17	80	162.3	174	146
18	85	167	176	154.5
19	90	171.7	178	163
20	95	176.3	181	171.5
21	100	180	184	180

12.0 Dimensional Detail

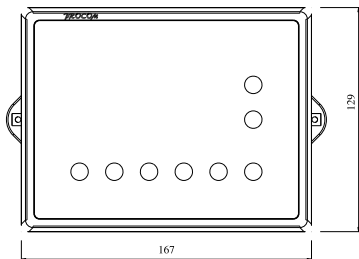

Front View

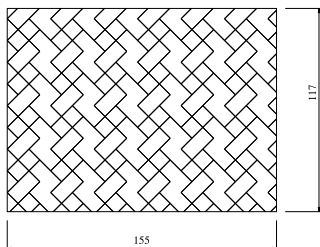

Cut Out

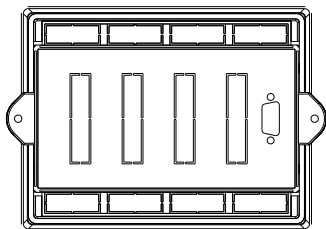

Rear View

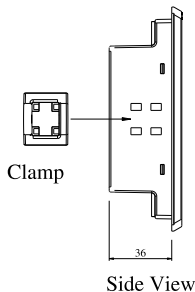

Side View

MRM *PROCOM*[®] Pvt. Ltd.
Plot No. 20-21, Industrial Estate
Sector-59 (II), HUDA, Faridabad-121004, Haryana
Phone: 0129-4700400 (10 Lines), E-mail : info@mrmprocom.com
Website : www.mrmprocom.com